

SA1

SINGAPORE CHINESE GIRLS' SCHOOL (PRIMARY)

FIRST SEMESTRAL ASSESSMENT 2021

NAME: _____ ()

DATE: 10 May 2021

CLASS: PRIMARY 6 SY / C / G / SE / P

Parent's Signature:

_____**SCIENCE****BOOKLET A**

28 questions

56 marks

Total time for Booklets A & B: 1 h 45 min

DO NOT OPEN THIS BOOKLET UNTIL YOU ARE TOLD TO DO SO.**FOLLOW ALL INSTRUCTIONS CAREFULLY.**

A - 1

Part I (56 marks)

For each question from 1 to 28, four options are given. One of them is the correct answer. Make your choice (1, 2, 3 or 4). Shade the correct oval (1, 2, 3 or 4) on the Optical Answer Sheet.

1. Study the flowchart below,

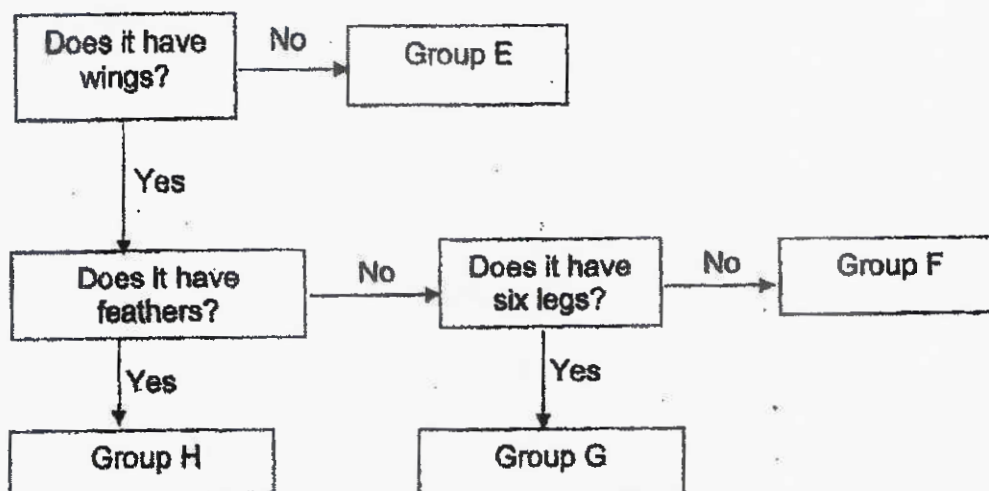

Which group does the butterfly belong to?

- 1) Group E 3) Group G
 2) Group F 4) Group H
2. Megan mixed 4 powdered substances P, Q, R and S together. Then she realised that she had made a mistake and wanted to separate the substances. The table below shows the properties of the four substances.

Substance	Floats on water	Is a magnetic material
P	✓	
Q	✓	
R		
S		✓

Which 2 substances will Megan have the most difficulty separating?

- 1) P and Q 3) P and S
 2) P and R 4) Q and R

3. The diagram below shows the human digestive system.

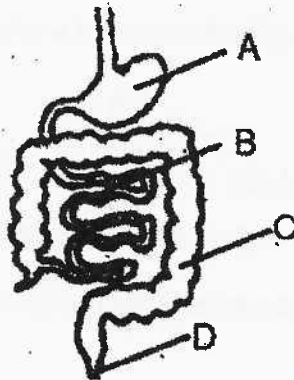

In which part/s, A, B, C, or/and D, does/do digested food get absorbed into the bloodstream?

- 1) B only
2) A and B only
3) B and C only
4) B, C and D only
4. Alison wanted to find out if the exposed surface area of water would affect the rate of evaporation. She set up an experiment by placing all the containers below at the same place. She added water to all the containers. After checking the details of Alison's experiment, her teacher told her that her experiment was not a fair one.

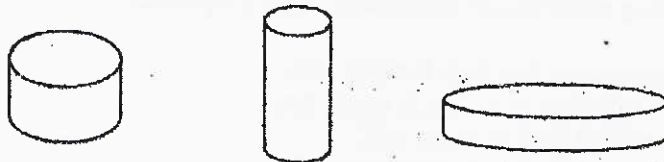

What should Alison do to ensure that her experiment is a fair one?

- A : Place all the containers at different locations.
B : Make all the containers the same size and shape.
C : Make the water level the same for all containers.
D : Make the volume of water the same for all containers.

- 1) A only
2) D only
3) B and C only
4) A and D only

5. The diagrams below show the life cycles of a chicken and a grasshopper.

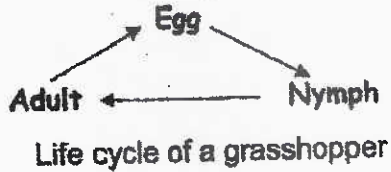
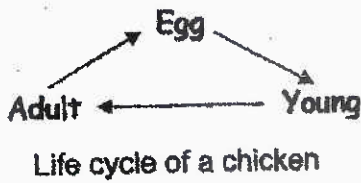

Which one of the following statements about the 2 life cycles are correct?

- A : The young in both life cycles moult.
- B : Both life cycles have three stages.
- C : The young in both life cycles look like the adult.
- D : The adults in both life cycles reproduce by laying eggs on land.

- 1) A and B only
- 2) B and C only
- 3) A, C and D only
- 4) B, C and D only

6. The diagram below shows two different cells, A and B.

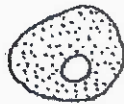

Cell A



Cell B

Which of the following statements about the cells is correct?

- 1) Cell A has regular shape but Cell B does not.
- 2) Cell B has cell membrane but Cell A does not.
- 3) Cell B has cell wall but Cell A does not.
- 4) Cell A has cytoplasm but Cell B does not.

7. Study the electrical circuit below. What is the least number of switches that must be closed for all the bulbs to light up?

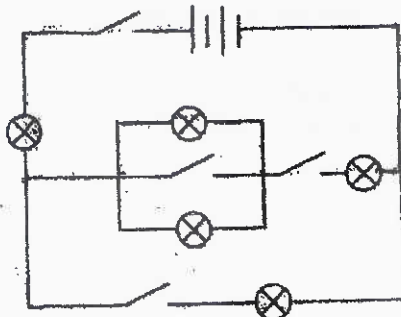

- 1) 1
- 2) 2
- 3) 3
- 4) 4

8. Study the diagram below. Objects S, T, U and V are of the same size but different mass.

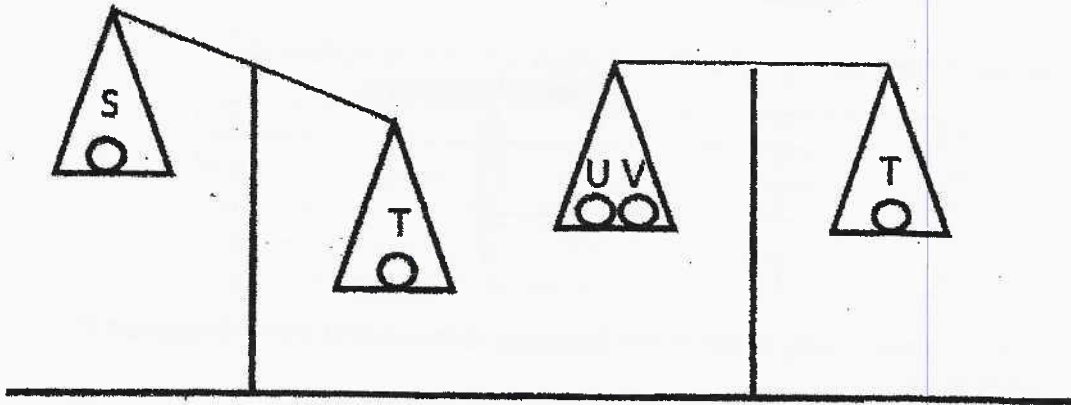

Which of the following diagrams below represents the possible situation?

1)

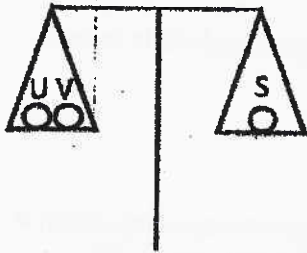

3)

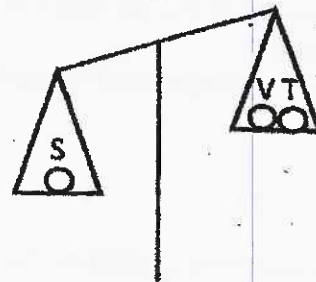

2)

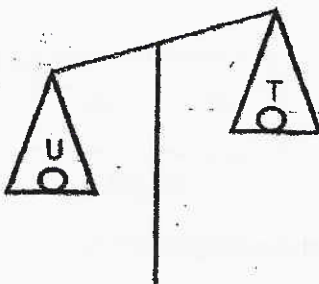

4)

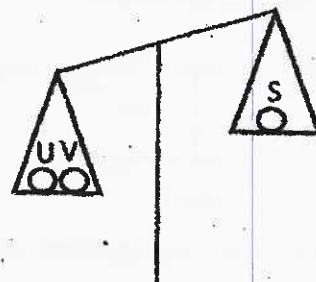

9. The effect of temperature on the life cycle of Organism P is studied. The results are recorded in the table below.

Temperature (°C)	Number of days for one complete life cycle to take place
15	45
20	25
25	15
30	10
35	7

Based on the table above, which of the following statement(s) about Organism P is definitely true?

- A: Organism P lays the most number of eggs at 15°C.
 B: The eggs of Organism P takes a longer time to hatch at 30°C than at 25°C.
 C: The duration of the life cycle of Organism P decreases as the temperature increases.
 D: The adult of Organism P lives the longest when the temperature is lowest.

- 1) A and B only
 2) B and C only
 3) C only
 4) C and D only

10. An experiment was carried out to find out the type of environment Organism X prefers. 30 Organism X were put in the middle of Tray A and Tray B. 10 minutes later, the number of organism X in each part of trays A and B were counted and shown below.

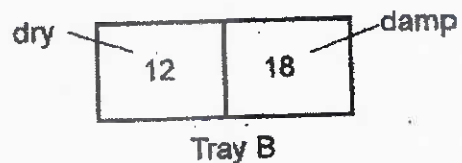
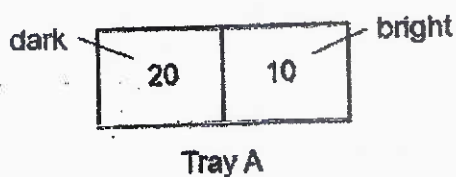

The experiment was repeated with Tray C using 30 similar Organism X.

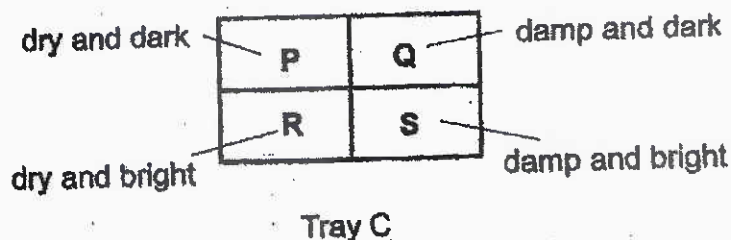

Which part, P, Q, R or S, of Tray C will most likely contain the greatest number of Organism X after 10 minutes?

- 1) P
 2) Q
 3) R
 4) S

11. Study the food chain shown below.

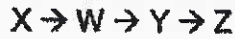

If the population of organism Z decreases from the above food chain, which one of the following graphs correctly shows the changes in the other populations?

1) Number of organisms

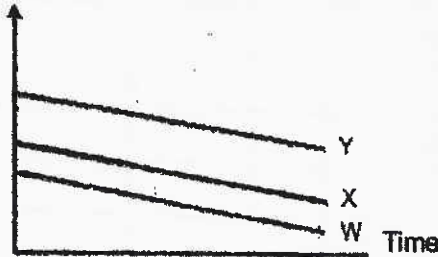

3) Number of organisms

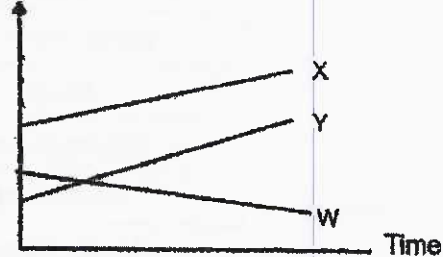

2) Number of organisms

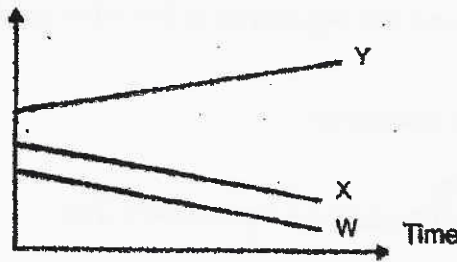

4) Number of organisms

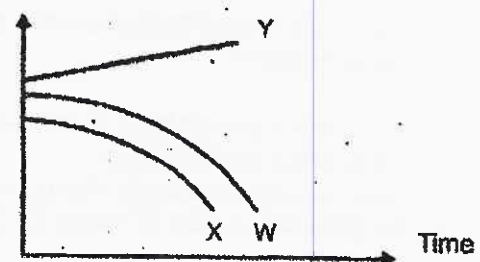

12. The chart below shows birds A, B, C and D with different beaks.

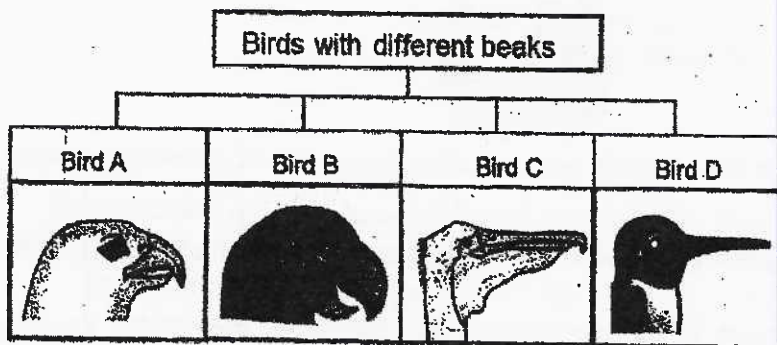

Which of the following correctly shows the food eaten by birds A, B, C and D?

	Bird A	Bird B	Bird C	Bird D
1)	rat	seeds	fish	nectar
2)	seeds	rat	nectar	fish
3)	nectar	fish	rat	seeds
4)	rat	nectar	seeds	fish

13. A group of pupils observed and recorded the number of organisms in a pond community.

Types of Organism	Organisms	Number of organisms
Plant	Water hyacinth	3
	Water lily	10
	Water moss fern	70
Animal	Guppy	8
	Mosquito pupa	4
	Pond skater	3
	Mosquito adult	3
	Mosquito larva	1

Which of the following statements about the organisms in the pond community above is correct?

- 1) There are 5 populations of animals altogether.
- 2) There are 2 communities.
- 3) There are more animals than plants.
- 4) The population size of mosquito is the same as that of the guppy.

14. Margaret is having a fever and her mum placed an ice pack on her forehead.



Explain how the ice pack helps to bring Margaret's temperature down.

- 1) The ice pack will gain heat from Margaret, making her lose heat.
- 2) The ice pack will absorb heat from Margaret, making her gain heat.
- 3) The ice pack will lose heat to Margaret, making her gain heat.
- 4) The ice pack will conduct coldness to Margaret, making her lose heat.

15. Alice wanted to test the magnetic strength of magnets A, B, C and D. She carried out an experiment to find out which is the strongest magnet by slowly pushing each magnet along a table towards a paper clip till the paper clip was attracted by the magnet as shown below. The diagram shows the maximum distance between the paper clip and the magnet for attraction to occur.

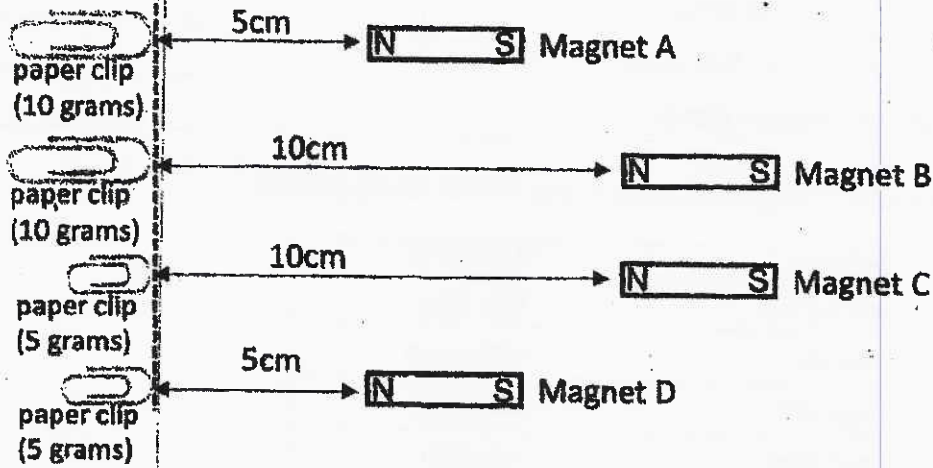

Which statement is true for the above set-up?

- 1) Magnet D is the strongest magnet.
- 2) Magnet A is the weakest magnet.
- 3) Magnet D is stronger than Magnet B.
- 4) Magnet B is stronger than Magnet C.

16. The diagram shows the circulation of blood in a human body. A, B, C and D represent the blood vessels.

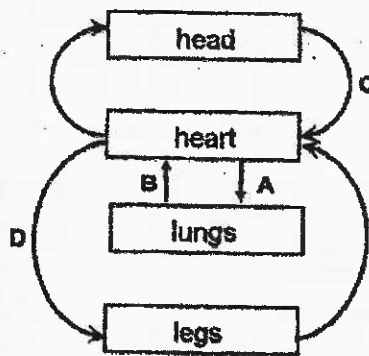

Based on the diagram above, which of the following correctly identifies the blood vessels rich in oxygen and carbon dioxide respectively?

	Blood rich in oxygen	Blood rich in carbon dioxide
1)	A	D
2)	B	C
3)	C	A
4)	D	B

17. Mary conducted a study on two types of habitat and recorded her observations in the table below. A tick (✓) shows that the observation is made.

Observation	Habitat A	Habitat B
Woodlouse and bracket fungus are found.	✓	
The place is moist and shady.	✓	
Butterflies are flying in this area.		✓
Pesticides are used on plants.		✓

Which of the following do Habitat A and Habitat B represent?

	Habitat A	Habitat B
1)	rotting log	leaf litter
2)	garden	rotting log
3)	garden	leaf litter
4)	leaf litter	garden

18. Below is a classification chart. What could Method X, Fruit Y and Fruit Z be?

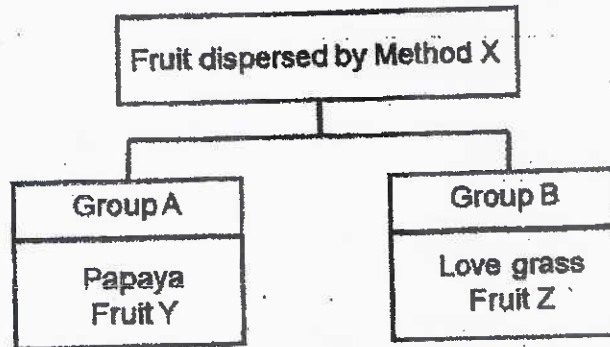

	Method X	Fruit Y	Fruit Z
1)	animal	guava	mimosa
2)	water	coconut	rubber
3)	water	coconut	pong pong
4)	animal	mimosa	rubber

19. Jo conducted an experiment on 4 flowers from a plant in her garden. Each of the flowers had both male and female parts.

The table below shows the various parts Jo removed from each flower.

Parts removed	Flower D	Flower E	Flower F	Flower G
Ovary		X		
Anthers	✓		✓	
Petals	✓			✓

From the information provided in the table, which of the flowers would still be able to produce fruits?

- 1) E only
 2) D and F only
 3) E and G only
 4) D, F and G only
20. Amy balanced two similar 400cm^3 containers, each containing 100ml of water, on a balance as shown in the diagram below.

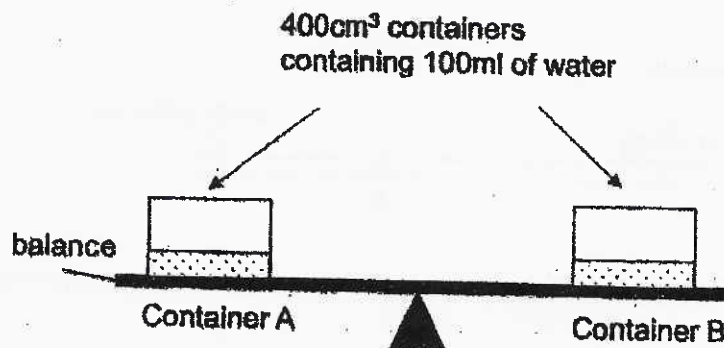

Amy pumped in an additional 100cm^3 of air into container A but did not pump any air into container B.

Which of the following statements is/are correct?

- A: The balance remained balanced.
 B: Container A will move downwards.
 C: The volume of air in Container A remained unchanged.
 D: The volume of air in Container A increased.

- 1) A only
 2) A and C only
 3) B and C only
 4) B and D only

21. The table below indicates the boiling and freezing points of substances X, Y and Z.

Substance	Freezing Point	Boiling Point
X	4	120
Y	30	60
Z	10	110

Based on the table above, which of the following conclusions could be made of the substances X, Y and Z?

	Liquid at 20°C	Gas at 100°C
1)	X only	Z only
2)	Y only	Z only
3)	X and Y only	Y only
4)	X and Z only	Y only

22. A magnet was placed on a steel table top. A push was exerted on the magnet to move it horizontally across the table from point A to point B as shown in the diagram below.

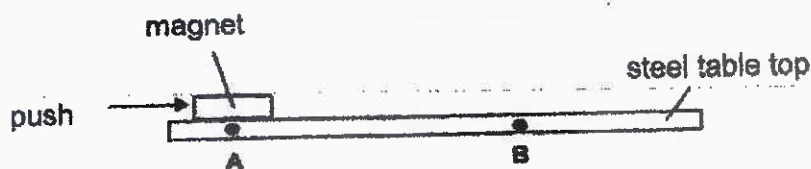

Which of the following force(s) must the push overcome so that the magnet moved from point A to point B?

- 1) Frictional force only
- 2) Gravitational force only
- 3) Frictional force and magnetic force only
- 4) Frictional force, magnetic force and gravitational force

23. Amy used the set-up below to find out the time taken for the wooden block to slide down two different surfaces, A and B.
Surface A is a carpet surface while surface B is a steel surface.

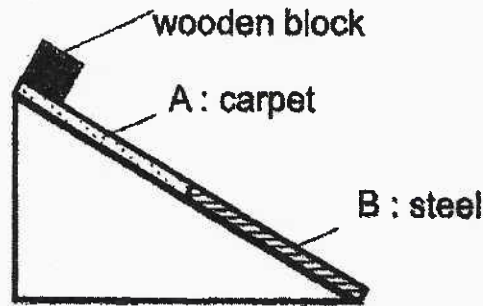

Which one of the following graphs below correctly shows the time taken for the wooden block to slide down the two surfaces?

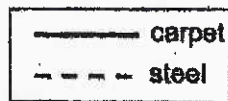

1) Distance travelled by block

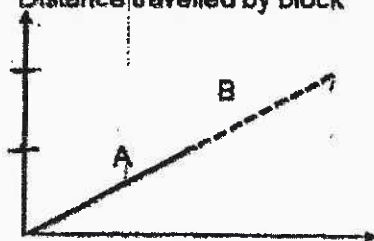

Time

3) Distance travelled by block

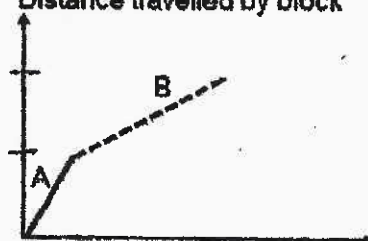

Time

2) Distance travelled by block

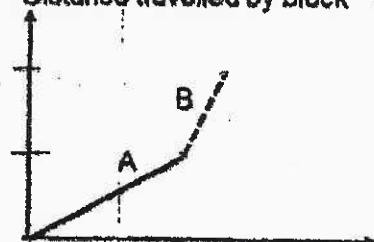

Time

4) Distance travelled by block

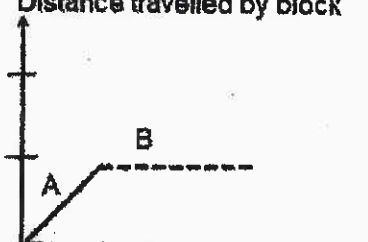

Time

24. Linda took a leaf and placed it in the dark for 2 days to remove its starch. The leaf was covered with aluminium foil as shown in Diagram 2 and was then put in the sun. The leaf was tested for starch with iodine solution 5 hours later.

Note: Iodine turns dark blue when it reacts with starch.

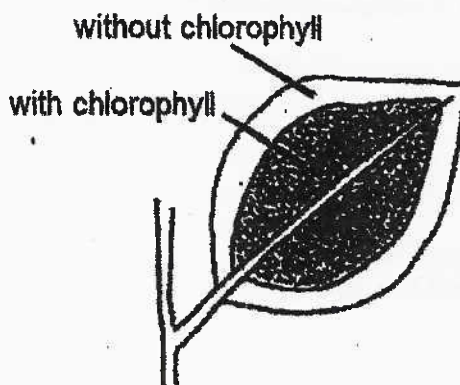

Diagram 1

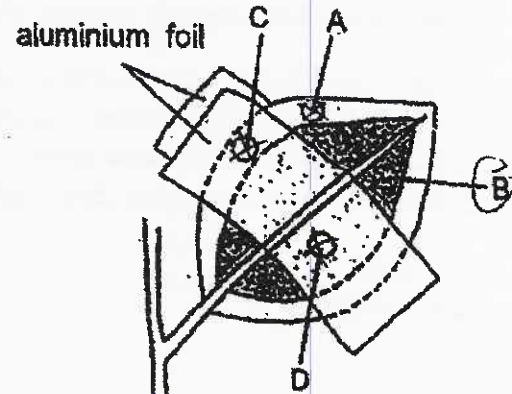
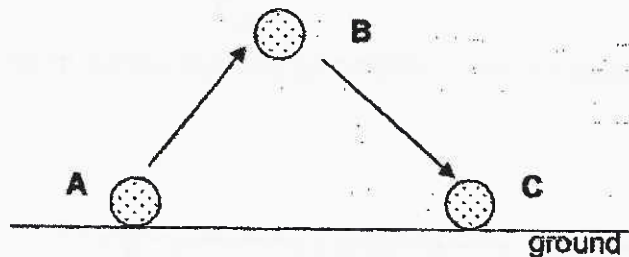

Diagram 2

In which area, A, B, C or D, will the iodine solution turn dark blue?

- 1) B only
 - 2) C and D only
 - 3) A and B only
 - 4) A, B, C and D
25. Ken kicked a ball at A and it travelled through air from A to B, and then from B to C.



Which of the following statements is true?

- 1) Gravitational force acted on the ball only when it travelled from B to C.
- 2) There are no other forces acting on the ball from A to B except gravitational force.
- 3) The gravitational force of the ball at B is the same as the gravitational force of the ball at C.
- 4) The gravitational force acting on the ball increased when the ball travelled from A to B and decreased when it dropped from B to C.

26. Two identical balls, X and Y, are moving in the different directions and at different speeds on a surface.



Which of the following will happen after Ball X collides with Ball Y?

- A: Ball X and Ball Y will move together in the same direction.
 B: Ball X and Ball Y will move in opposite direction from each other.
 C: Ball X and Ball Y will slow down.
 D: Ball X will slow down but Ball Y will move faster.

- 1) A only
 2) A and D only

- 3) B and C only
 4) B and D only

27. Leo manufactures suitcases of different sizes. He uses a light sensor to count the number of suitcases in his factory. The suitcase is placed on a moving conveyor belt as shown below. The conveyor belt moves at a constant speed. When the suitcase is between the light source and the sensor, it blocks out the light from reaching the sensor.

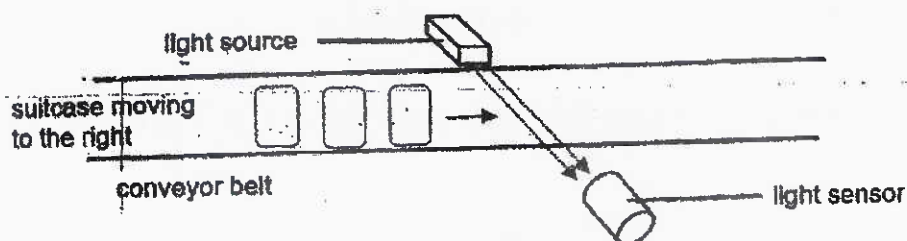

The graph below shows the data collected by the light sensor in 30 seconds.



How many suitcases passed through the light source in 30 seconds?

- 1) 5
 2) 6

- 3) 28
 4) 30

28. Leng Leng would like to put up a puppet performance as shown below. She observed how the size of the shadow changed when the puppet was moved towards the spotlight or the screen.

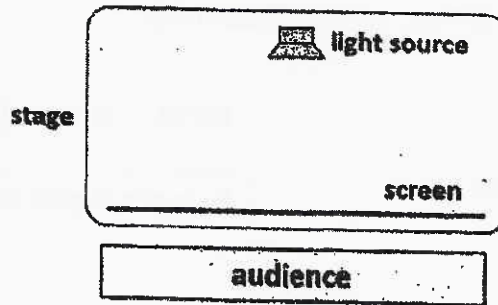

She used 3 similar puppets A, B and C of the same height. The diagram below showed the shadows formed on the screen when the spotlight was turned on.

Which of the following correctly shows the positions of the puppets?

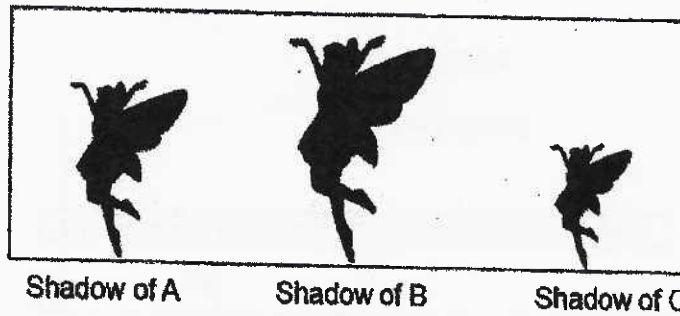

1)

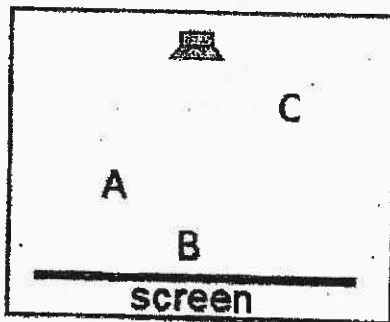

3)

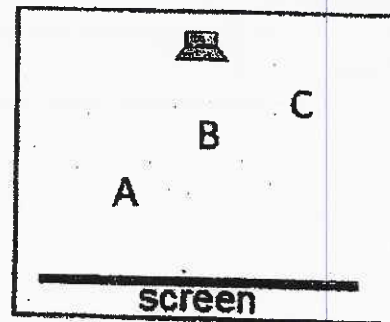

2)

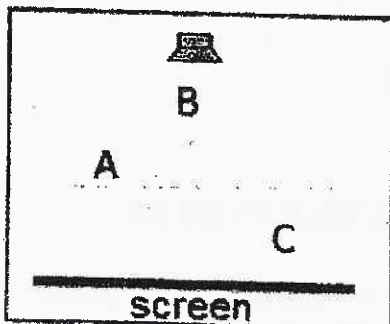

4)

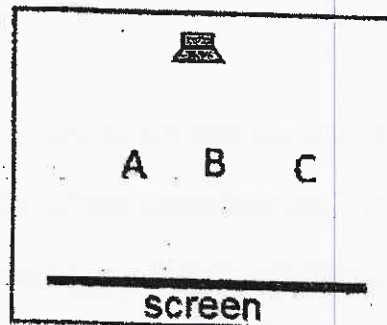

End of Booklet A

SINGAPORE CHINESE GIRLS' SCHOOL (PRIMARY)

FIRST SEMESTRAL ASSESSMENT 2021

NAME: _____ ()

DATE: 10 May 2021

CLASS: PRIMARY 6 SY/C/G/SE/P

Parent's Signature:

SCIENCE

BOOKLET B

	Total Actual Marks	Total Possible Marks
Booklet A		56
Booklet B		44
Total		100

13 questions

44 marks

Total time for Booklets A & B: 1 h 45 min

DO NOT OPEN THIS BOOKLET UNTIL YOU ARE TOLD TO DO SO.**FOLLOW ALL INSTRUCTIONS CAREFULLY.**

Part II (44 marks)

Answer all the following questions.

29. Esther filled a cup with solid Substance X and heated it over a flame for a period of time. It was removed from the stove to cool on a table. The graph below shows the changes in the temperature of Substance X over a period of time.

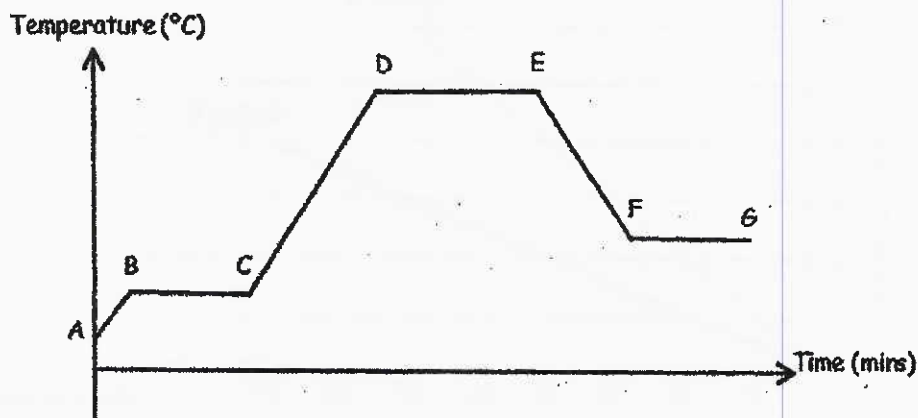

Put a tick (✓) in the appropriate column if the statement is true or false based on the graph above. (2m)

	Conclusion	True	False
(a)	Substance X was melting between BC.		
(b)	Substance X has reached its boiling point at D.		
(c)	Substance X was gaining heat between DE.		
(d)	Substance X was freezing between FG.		

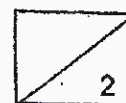

B - I

30. The graph below shows the extension of Spring A and Spring B when loads of different masses of weights were hung on it. The original length of Spring A and B is 10cm.

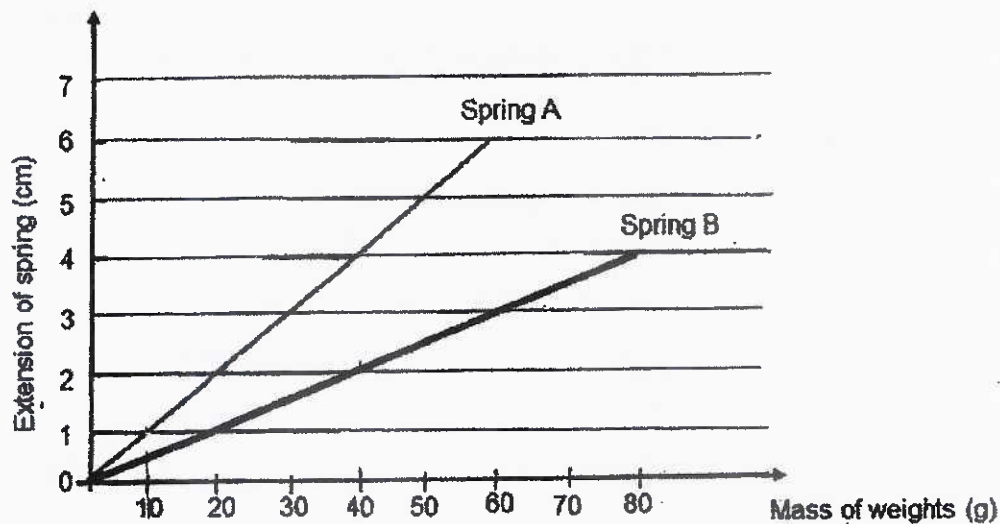

Answer the following questions based on the graph above.

- (a) What is the relationship between the mass of weights hung on Spring A and the extension of Spring A? (1m)
- _____
- _____
- (b) What is the length of Spring A when a mass of 40 g is hung on it? (1m)
- _____
- (c) Which spring, A or B, is stiffer? Explain your answer. (1m)
- _____
- _____



31. A metal ball was dropped from Position A onto the wooden plank at Position B. When the ball reached Position B, Position C of the wooden plank moved up and hit the drum that was fixed to a stand.

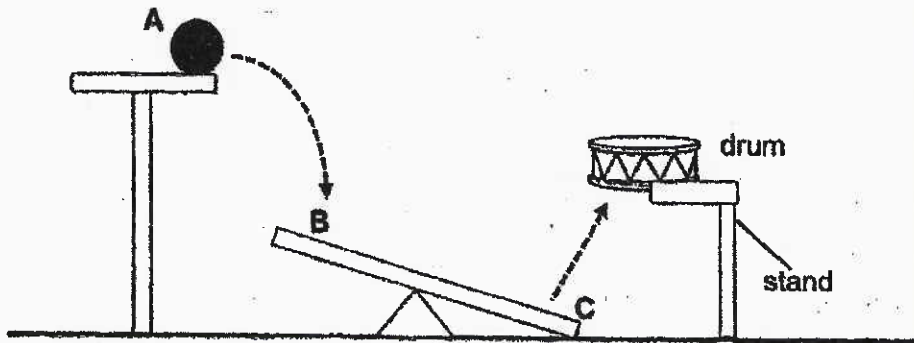

Fill in the blanks below to indicate the energy conversion in the set-up above. (2m)

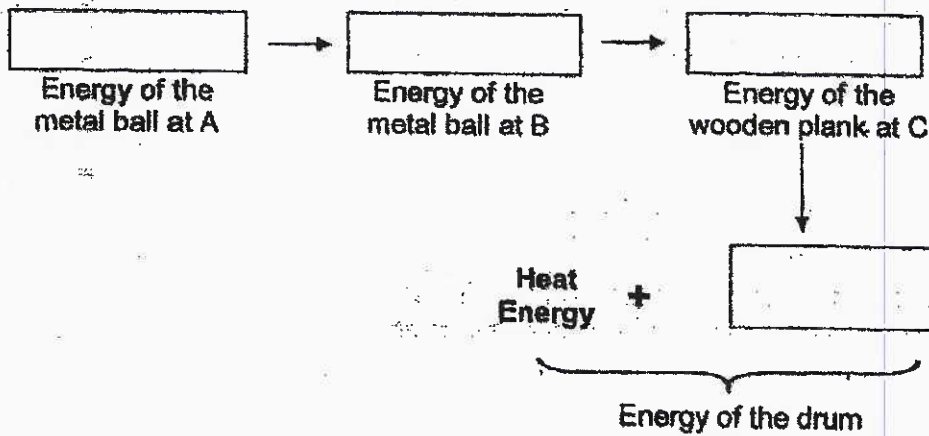

32. The diagram shows a toy gun.



When Alan pressed the trigger, the rubber band would be released. The rubber band would hit the paper and cause it to tear. He repeated the above experiment with toy guns of different lengths and recorded his observations in the table below.

Length of the toy gun (cm)	Size of the tear on the paper (cm)
5	2
7	4
9	6

(a) Name the energy possessed by the stretched rubber band. (1m)

(b) Based on the results in the table above, explain why the size of the tear on the paper became bigger when the length of the toy gun was longer. (2m)

(c) Alan presented his results in the graph below.

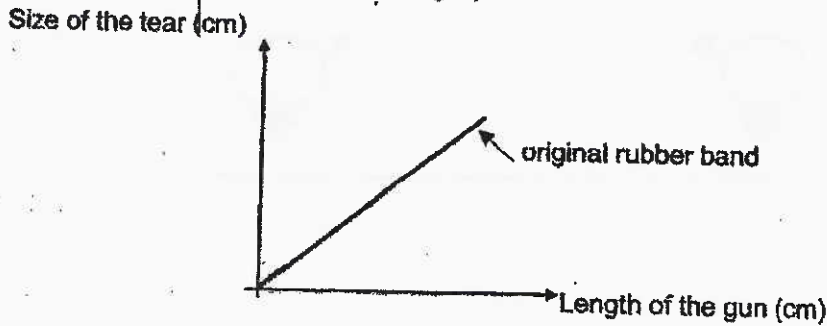

Alan repeated the experiment using a shorter rubber band (smaller loop) made of the same material. Use a blue pen to draw a straight line in the graph above to show the new relationship between the length of the gun and the size of the tear on the paper. (1m)

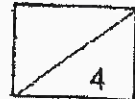

33. Adam created a circuit board with 4 bulbs, P, Q, R and S, located at each of the corner of the circuit board. When the circuit was closed, only 2 bulbs lit up and he observed shadows of the two wooden sticks directly on the circuit board as shown below.

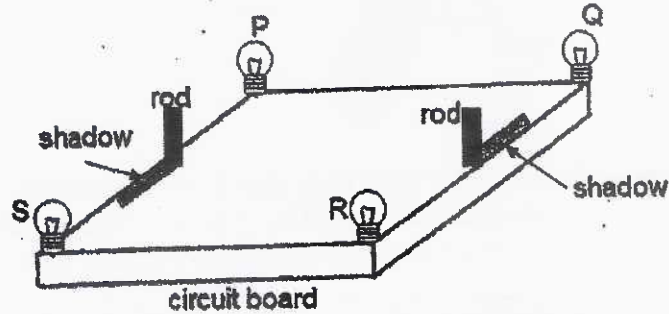

- (a) Which 2 bulbs were lit up? (1m)

- (b) Draw the wires in the diagram provided above to show how the circuit is connected so that only the 2 bulbs are lit up as indicated in (a). (2m)

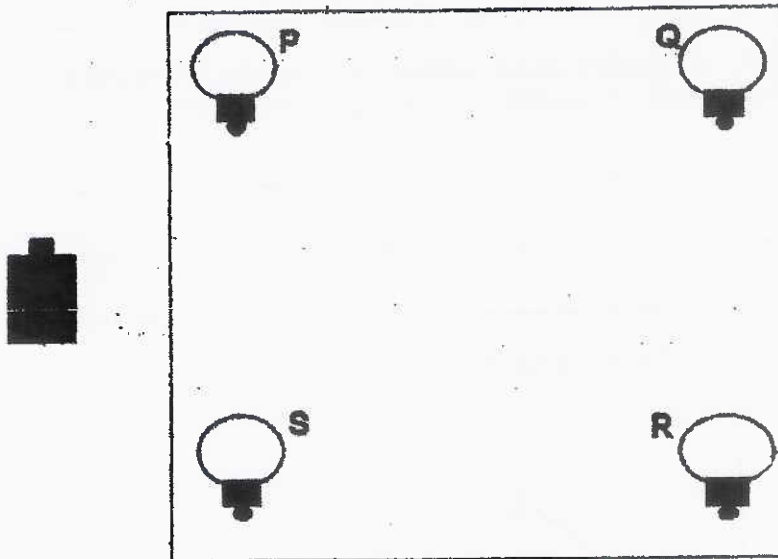

34(a) Kate set up the experiment below.

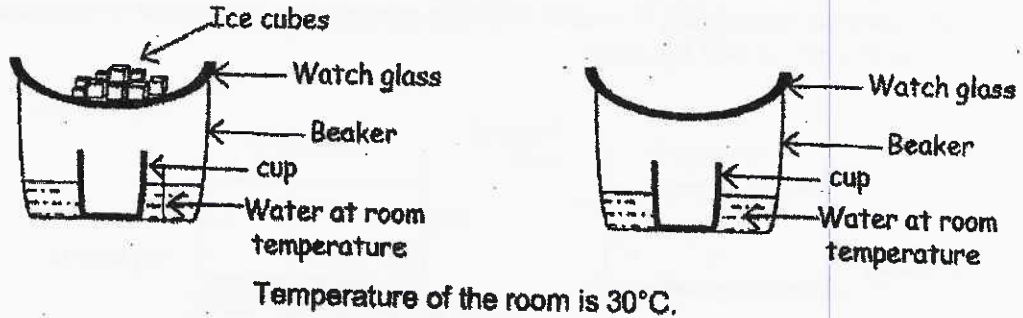

Set-up A

Set-up B

- (i) Explain why water was collected in the cup in Set-up A but not in Set-up B after 40 minutes. (2m)

- (ii) Kate changed the water in Set-up A to 90°C. Will there be more, less or same amount of water collected in the mug after 40 minutes as compared to when water at 30°C was used? (1m)

- (b) It was winter. Kate's family got into a car in the morning and her father turned on the heater in the car. After a while, Kate noticed that the windscreen and the windows had become misty.

Temperature inside the car is 25°C



Temperature of the surrounding air outside is 5°C

On which surface, inner or outer, of the windscreens and windows would Kate find the water droplets? Explain your answer. (2m)

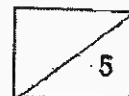

- 35(a) The diagram below shows 2 iron hot plates, P and Q.
Two identical containers, P and Q, with the same amount of water were placed on the respective iron hot plates.

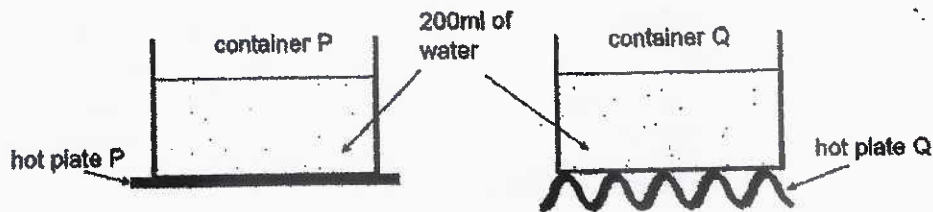

- (i) Explain why the water in Container P boiled first. (2m)

- (ii) Explain why the material for iron hot plates, P and Q, has to be kept the same to ensure a fair test. (1m)

- (b) Two identical glasses, A and B, were filled with different amounts of water at 30°C. They were placed on the same hot plate. The glasses of water were heated till the water in each glass boiled.

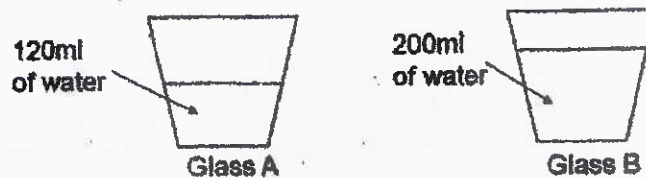

- In which glass, A or B, would it take a longer time to boil? Explain your answer. (1m)



36. The food web below shows the food relationship of the organisms found around a farm. The farmers used insecticides excessively to kill Insect X and Y. Other organisms are not killed by the insecticides.

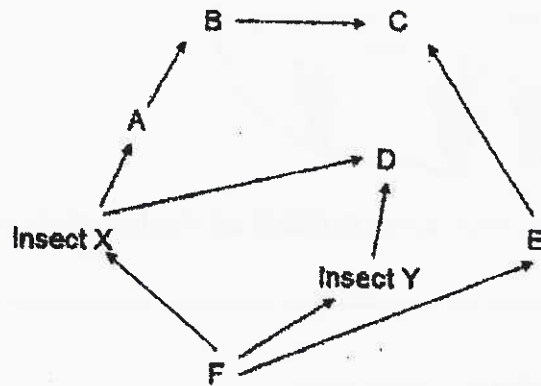

- (a) Name the food producer. (1m)
-
- (b) From the above food web, draw a food chain with 5 organisms. (1m)
-
- (c) Besides Insects X and Y, which 2 organisms will definitely decrease with the use of insecticides? (1m)
-
- (d) Name an organism that is both a prey and a predator. (1m)
-

37. Plant X is a submerged water plant that has adaptation to stay as near the water surface as possible.

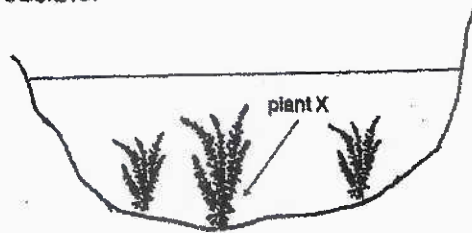

(a) State an adaptation that Plant X has to obtain as much sunlight as possible. (1m)

(b) Alice keeps some guppies in a small pond.

(i) She noticed that the guppies spend most of the time swimming near the surface of the water. Explain why the guppies are behaving this way. (1m)

(ii) Alice's mother advised her to add some water plants to the pond. Explain how this may reduce the number of guppies swimming near the surface. (1m)

Upon listening to her advice, Alice bought some water lettuce plants for the pond. However, after a few weeks, the guppies are still swimming to the surface of the water pond.

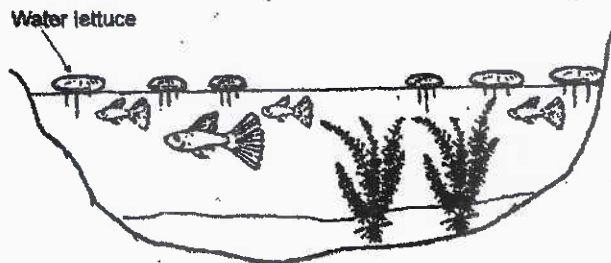

(iii) Explain why the guppies are still swimming near the surface of the water. (1m)

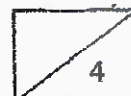

38(a) Study the diagram below.



Mushroom



Fern

(i) How do the mushroom and fern reproduce? (1m)

(ii) State the method of dispersal for the fern to reduce overcrowding. (1m)

(b) The diagram below shows fruits of Plant C and Plant D.

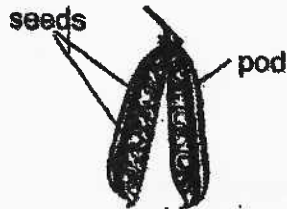

Fruit of Plant C



Fruit of Plant D

Explain why the seeds of Plant D have a higher chance of growing into healthier new plants than the seeds of Plant C? (2m)

39. The diagram below shows the cross-section view of a stem.

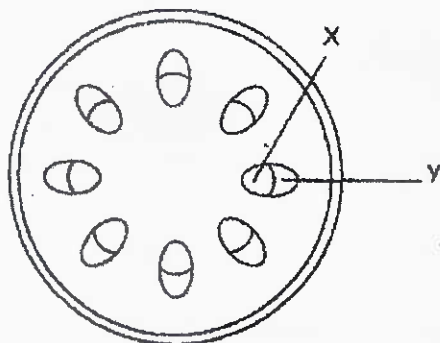

- (a) State substances X and Y. (1m)

Substance X : _____ Substance Y : _____

A ring of stem is removed from the tree below.

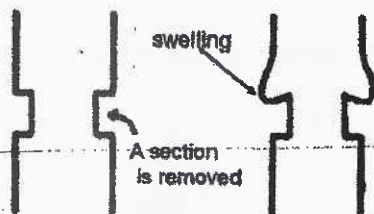

After a few days, swelling is observed above the cut area.

- (b) What has been removed from the stem that caused the swelling shown in the diagram above? (1m)

- (c) The tree died after one month. Explain why this happened. (1m)

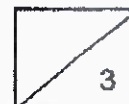

40. Dilan wanted to investigate the effect of moist bread on liquid X. He wrapped a piece of moist bread in a bag with tiny holes and then hung it in a beaker as shown below. The setup was left at room temperature 30°C for 5 days.

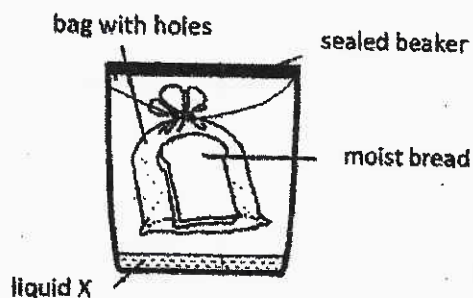

Set-up P

	Amount of carbon dioxide	
	Low	High
Colour of liquid X	Red	Yellow

- (a) Explain why liquid X turned from red to yellow in the Set-up P on the 5th day. (1m)

- (b) Dilan's teacher thinks that Dilan should set up a control for his experiment. Draw and label the control setup. (1m)

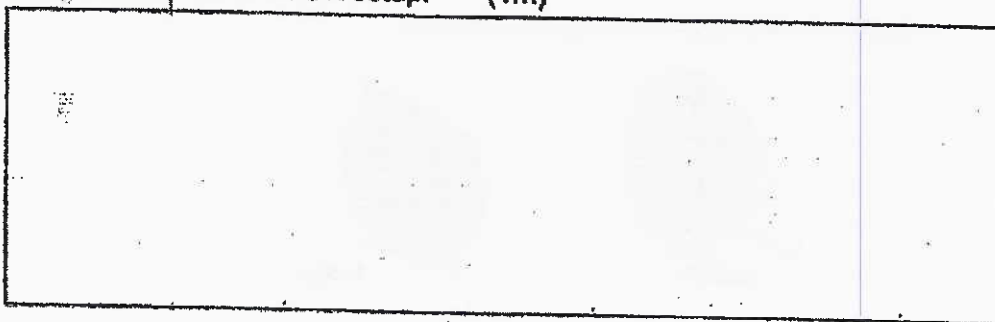

- (c) Dilan prepared another 2 set-ups, Q and R, which were similar to set-up P. Set-up Q was placed in the air-conditioned room but Setup R was placed at room temperature 30°C with the bread toasted and cooled before the experiment.

Put a tick (✓) in the appropriate column to show if liquid X take 'less than 5 days' or 'more than 5 days' to turn yellow for setup Q and R. (1m)

		Less than 5 days	More than 5 days
(i)	Setup Q		
(ii)	Setup R		



41. The diagram shows trees with a shape that are commonly found in countries with heavy snowfall. The trees have structural adaptations to help them cope with the low temperatures and heavy snowfall.

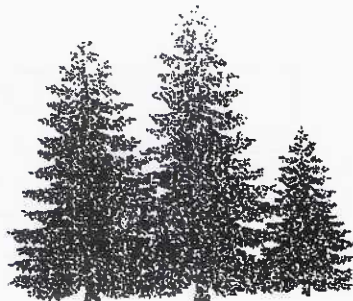

- (a) After a heavy snowfall, snow collects on the branches of trees and might break the branches.
Explain how the tree shape shown above helps to prevent this from happening. (1m)

- (b) The diagram below shows two types of leaves.

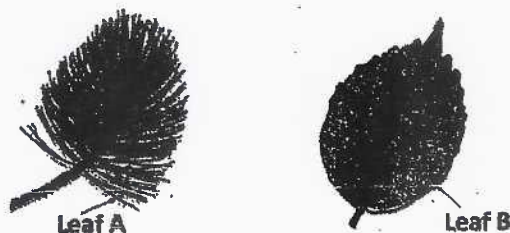

- (i) Explain why Leaf A is better adapted for preventing the leaf stalk from breaking due to snow build-up than Leaf B. (1m)

- (ii) There is less water available for the trees during winter months. Explain how Leaf A is better adapted than Leaf B when less water is available. (1m)

ANSWER KEY

YEAR : 2021
LEVEL : PRIMARY 6
SCHOOL : SCGS
SUBJECT : SCIENCE
TERM : MID-YEAR EXAM

BOOKLET A

Q1	3	Q2	1	Q3	1	Q4	2	Q5	4
Q6	3	Q7	3	Q8	4	Q9	3	Q10	2
Q11	3	Q12	1	Q13	4	Q14	1	Q15	4
Q16	2	Q17	4	Q18	1	Q19	4	Q20	3
Q21	4	Q22	3	Q23	2	Q24	1	Q25	3
Q26	2	Q27	1	Q28	2				

Name: _____ Class: 6

2021 P6 SA1 Suggested Answers	
29	a) T b) T c) T d) F
30a	As the mass of weight/ mass/ weights hung on A increases, the extension of Spring A increases.
30b	14cm (1m)
30c	Fix the length and compare the mass OR Fix the mass and compare the length: Spring B. It requires a larger mass to extend/stretch the same length as Spring A. OR When the same mass is hung on Spring A and B, B stretch less than A.
31	potential energy → kinetic energy → kinetic energy → sound energy (all or none)
32a	(Elastic) Potential energy
32b	When the length of the gun increased, the rubber band is stretched more, so it has/ stores more potential energy, which is converted to more kinetic energy, and hence caused a bigger tear.
32c	
33a	P and R

33b	
34a	All connections must be correct to get full marks. Must include explanation for both A and B. The watch glass was cooler than the water vapour in set-up A so condensation could take place. The watch glass was at the same temperature as / not cooler than water vapour in set-up B so condensation could not take place.
34ai	More
34b	Inner sides (of the windscreen and windows) AND Warmer water vapour inside the car touches the cooler surface of the glass loses heat and condenses to form water droplets.
35a	Container P has a greater surface area in contact with/ touching Hot Plate P, so the water in container will gain heat from the hot plate P faster / gain more heat from Hot Plate P.
35ai	Must mention how the results/ time taken to boil is affected: Changing the material will affect the result of experiment / affect how fast the water boils.
35b	Glass B. B has more water/ more volume of water so it needs to gain more heat to boil.
36a	F
36b	F → Insect X → A → B → C (All or none)
36c	A and D
36d	A OR B

37a	The water plants have all spaces in their stem/air in their stem/leaves to stay upright in water.
37bi	There is not enough dissolved oxygen at the bottom of the pond and the guppies must go nearer to the surface where there is more dissolved oxygen to breathe.
37bii	The water plants will photosynthesize and produce oxygen for the guppies.
37b iii	The water lettuce will give out oxygen to the air above water and not into the water for the guppies. OR The water lettuce blocks the sunlight, so plant X cannot photosynthesis and produce sufficient oxygen for the guppies.
38a	It reproduces by spores.
38ai	By wind dispersal method
38b	Must base explanation on dispersal methods of C and D. Note that it is the seeds which disperse, not the fruits, especially Plant C. Plant D disperses its seeds by animals and Plant C disperses its seeds by splitting method. Thus Plant D's seeds can travel a longer/further distance away from the parent plant to reduce overcrowding/reduce competition for space/mineral salts, water and sunlight
39a	Substance X : Water or mineral salts Substance Y : Glucose or food or sugar
39b	Phloem OR food-carrying tubes
39c	The food-carrying tubes <u>cannot transport food</u> from the leaves to the roots, so the roots will die and cannot take in/absorb water, so the tree died
40a	The bread has decomposed and the mould/ bacterial decomposition <u>produced carbon dioxide</u> .

40b	Recall - A control removes the item/ substance causing the result Control setup (must remove the bread)
40c	(i) Set-up Q : More than 5 days (ii) Set-up R : More than 5 days
41a	Must explain based on SHAPE of the tree, not the leaves or stem etc. The shape of the tree causes snow to fall off/slide down from the top of the tree and does not collect on its upper branches, thus preventing its branches from breaking due to extra mass of the snow.
41bi	Leaf A has <u>more gaps</u> to allow more snow to fall through so that the snow will <u>not collect</u> on the leaves.
41bii	Leaf A has the smaller surface area which has fewer stomata to <u>lose water</u> , thus Leaf A loses less water than Leaf B.

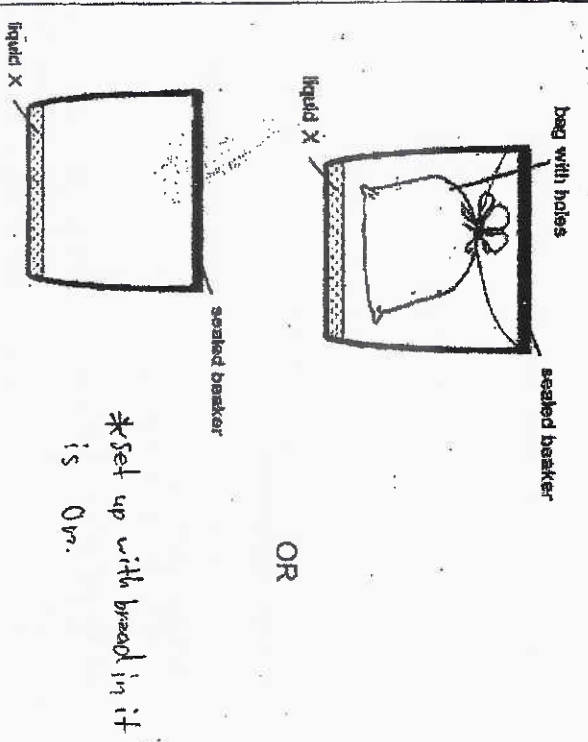

3
END